



# Public Hotspot Konzepte

Wolfram Maag  
Internetworking Consultant  
wmaag@cisco.com

DT Service © 2002, Cisco Systems, Inc. All rights reserved. 1



## Public Access



Hotspot Munich Airport © 2003, Cisco Systems, Inc. All rights reserved. Company Confidential 2

## Agenda

Cisco.com

- **Public Access Market**
  - Market Overview
  - Mobility – Positioning of PWLAN
  - Market Evolution
- **Cisco's Public Access Solutions**
  - Products
  - Integrated Systems; Features & Architectures

Hotspot Munich Airport

© 2003, Cisco Systems, Inc. All rights reserved.

Company Confidential

3

## Public Access hat besondere Herausforderungen

Cisco.com



- **Unbekannte User**
- **Keine Kontrolle über Clients**
- **Kein IT Personal zur Unterstützung der End-User**
- **Security**
- **Session Management**

Hotspot Munich Airport

© 2003, Cisco Systems, Inc. All rights reserved.

Company Confidential

4

## Enterprise Guest Access ist eine wichtige Ergänzung zum Unternehmensnetzwerk

Cisco.com

- **Internet access für Besucher und Consultants**
  - Professionelles Image für Besucher
  - Besserer Service für Lieferanten und freie Mitarbeiter
  - Bessere Zusammenarbeit zwischen eigenem Personal und Gästen
- **Security bleibt erhalten**
- **Reduziert IT support**



*Enterprises Kunden ist das wichtigste Segment !*

Hotspot Munich Airport

© 2003, Cisco Systems, Inc. All rights reserved.

Company Confidential

5

## BBSM im Gesundheitswesen

Cisco.com

- **Full VPN support with BBSM's Multi-net functionality. Users select private or public IP's depending on their VPN requirements**
- **Utilize BBSM's Bandwidth Manager to enforce service level and prevent resource drain**
- **Complete plug and play access to overcome static IP, DNS, and proxy settings so end users are not required to reconfigure their devices**
- **Walled garden (free links) to highlight services, hospital directories, patient education material and other useful guest information**

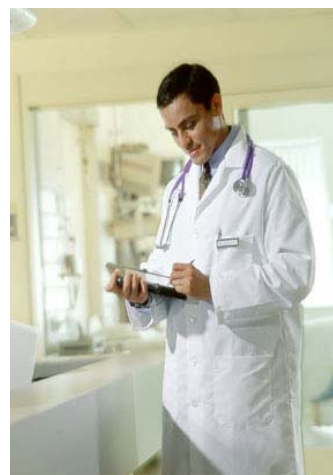

Hotspot Munich Airport

© 2003, Cisco Systems, Inc. All rights reserved.

Company Confidential

6

## BBSM hilft Hotels Kunden zu gewinnen und zu behalten

Cisco.com

- **Plug and play end-user connections**
- **Support for widest range of end-user VPNs**
- **Direct billing to the room**
- **Meeting-room access**
- **Customizable connect screen and walled garden**
- **Bandwidth management and tiered service levels**



Hotspot Munich Airport

© 2003, Cisco Systems, Inc. All rights reserved.

Company Confidential

7

## Network Operators

Cisco.com



- **Site Owner**  
Installs and operates PWLAN and broadband  
➤ **Enterprise, Hotel, coffee shop, airport, retail store, hospital**
- **Service Provider – Network Operator**  
Installs and operates PWLAN, broadband, transport network and data center. Roaming agreements  
➤ **Mobile Operators, ILECs/PTTs, Wireless ISPs**

Hotspot Munich Airport

© 2003, Cisco Systems, Inc. All rights reserved.

Company Confidential

8

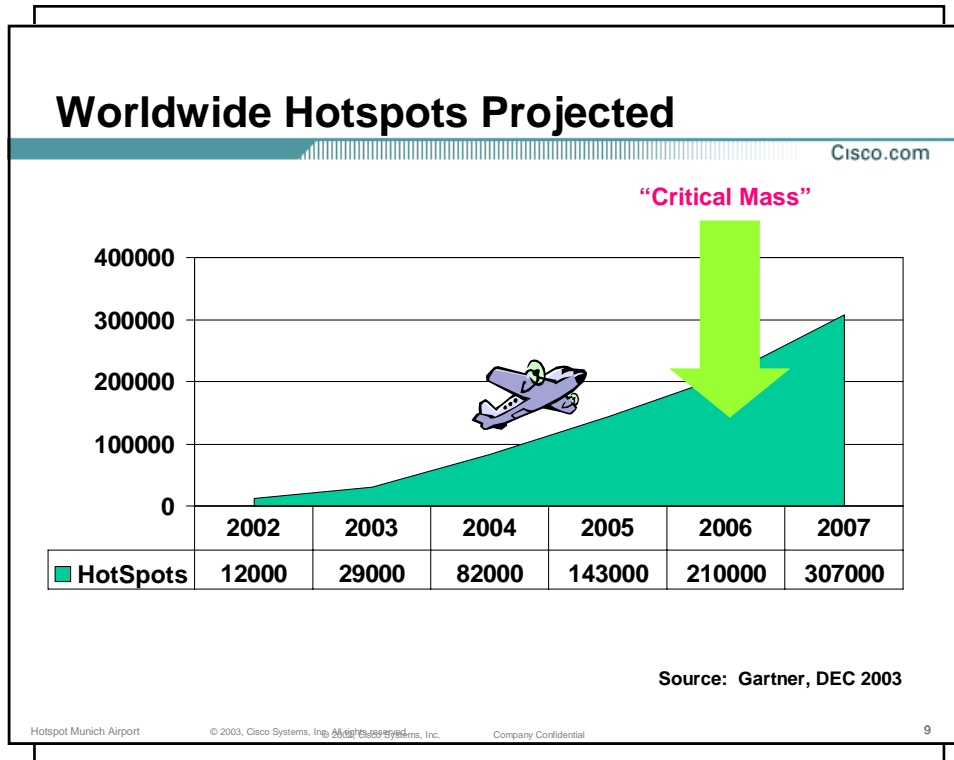



- ## Business Strategy
- Cisco.com
- **Target Users**
    - Business Travelers
    - Local Mobile Professionals
    - Consumer Verticals
  - **Hotspot Venue Strategy**
    - Business Travelers
      - Airports, Hotels, Conference Centers
    - Local Mobile Professionals
      - National Retail Chains (Starbucks, Bookstores, Gas Stations)
      - Verticals: Hospitals & Dr.'s Offices/Clinics, Truck Stops
    - Consumer Verticals
      - Sports Venues
- 
- Hotspot Munich Airport © 2003, Cisco Systems, Inc. All rights reserved. Company Confidential 10



# Access

DT Service © 2002, Cisco Systems, Inc. All rights reserved. 11

## Cisco Aironet 1200 Series Access Point



- **Simultaneous** dual-band operation (802.11b/g + 802.11a)
- Field-upgradable radio modules
- Extra horsepower for software upgradability
- Rugged metal housing
- Inline and local power
- Variety of antennas
- Mounting bracket with lock
- **High performance**  
Long range  
High avg. throughput

**Available in 3 versions:**

- 802.11b-only
- 802.11b/g
- 802.11a-only
- Dual-band 802.11a+b

© 2002 Cisco Systems, Inc. Company Confidential 12

## Cisco Aironet 1100 Series Intelligent, Affordable, Enterprise-Class AP

Cisco.com

- **Single 802.11b radio**  
Field-upgradable to 802.11g
- **IOS operating system**
- **Variety of mounting configurations**
- **Integrated antenna**
- **Plenum rated plastic housing**
- **Line Power-over-Ethernet**



*Intelligent enterprise services  
at a lower total cost*

Hotspot Munich Airport

© 2003, Cisco Systems, Inc. All rights reserved.

Company Confidential

13

## Cisco Long-Reach Ethernet Solution

Cisco.com

### High Performance:

- **Ethernet connectivity over traditional phone wire (Cat 1-3)**
- **Co-exists with POTS and ISDN on the same wire and ADSL in the same bundle**
- **Supports range of profiles (2-15 Mbps) for optimizing performance in every environment at distances up to 5000 feet**

**New!** Rate Selection feature adds robustness and simplifies installation



**Includes Catalyst 2950  
Enhanced Image (EI)  
software features:**

**Availability  
Security  
Quality of Service**

Hotspot Munich Airport

© 2003, Cisco Systems, Inc. All rights reserved.

Company Confidential

14

## Cisco Building Broadband Service Manager (BBSM)



Hotspot Munich Airport      © 2003, Cisco Systems, Inc. All rights reserved.      Company Confidential      15

## Produkte

Cisco.com

### Cisco Building Broadband Service Manager (BBSM) managed Internet Access mit einfachem Plug & Play das keine Umkonfiguration und kein IT Personal braucht



Hotspot Munich Airport      © 2003, Cisco Systems, Inc. All rights reserved.      Company Confidential      16



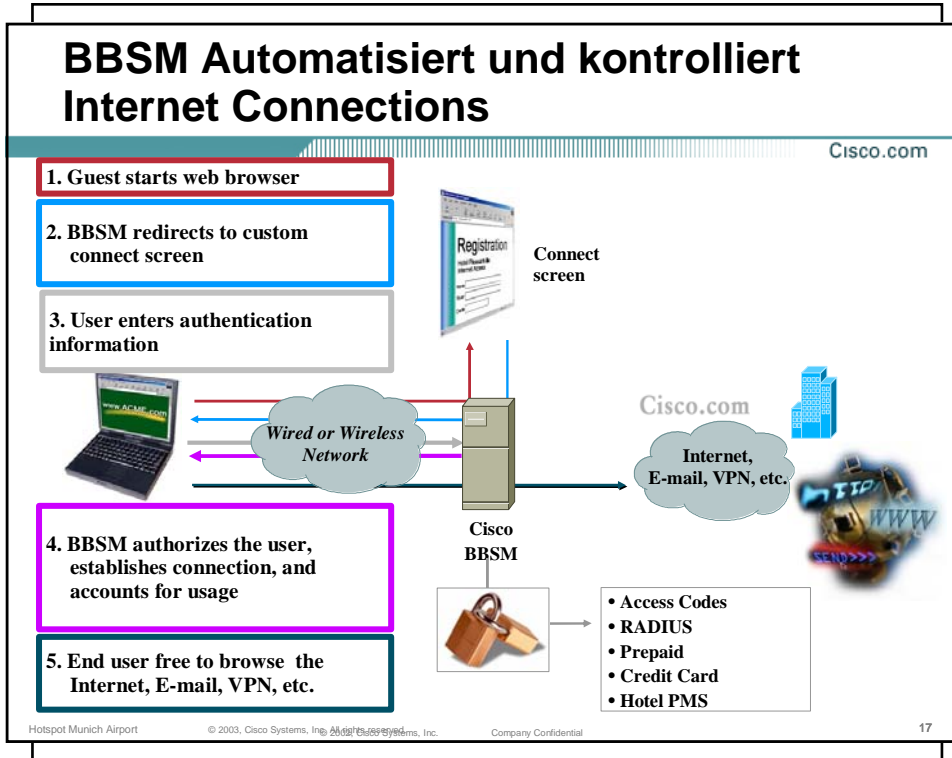

## BBSM Supported verschiedene Authentifizierungs und Billing Optionen

Cisco.com

	Enterprise Guests	Hotspots	Retail	Healthcare	Hotels	Colleges
Access Codes	X	X	X	X	X	
RADIUS - postpaid	X	X	X			X
Prepaid		X	X	X		X
Credit Card		X	X	X	X	X
Hotel PMS					X	

- BBSM enables both free and fee-based guest access
- It can be configured to support any combination of authentication methods concurrently

Hotspot Munich Airport    © 2003, Cisco Systems, Inc. All rights reserved.    Company Confidential    18

## End User Connect Screens ist frei konfigurierbar

Cisco.com

- Web based user authentication
- Corporate/site branding
- Links auf andere Info's
- Verschiedene Inhalte
  - Authentication Optionen
  - Billing
  - Bandbreiten Optionen
  - Walled Gardens (free zones)
- Volles Software Developers kit



Hotspot Munich Airport

© 2003, Cisco Systems, Inc. All rights reserved.

Company Confidential

19

## BBSM kann auch „Legal Disclaimer“ für den Internet Access Service zeigen

Cisco.com

Custom Legal Disclaimers can be easily presented during the authentication process

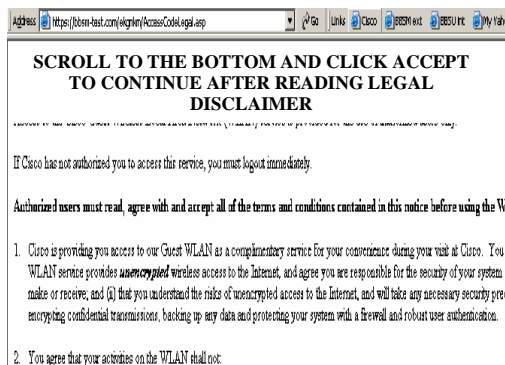

Hotspot Munich Airport

© 2003, Cisco Systems, Inc. All rights reserved.

Company Confidential

20

## BBSM bietet Management und Security Features

Cisco.com

<b>Central management module</b>	Easily update multiple BBSM servers Aggregate reporting from many BBSM servers
<b>Web-based reporting and configuration GUI</b>	Full secure management and reporting access via the web
<b>BBSM health page</b>	Allows administrator to see system summary to simplify management and diagnostics
<b>System fault monitoring and SNMP trap alerts</b>	Increased manageability using standard network management tools
<b>SSL administrative web pages</b>	Increased remote management security
<b>Security hardening</b>	Protect BBSM from hacking or other threats
<b>Dual VLAN support</b>	Allows for end users and network devices to reside on separate secure VLANs
<b>Duplicate IP address support</b>	Prevents IP hijacking by challenging all duplicate IP users for credentials End user experience improved; no IP conflicts

Hotspot Munich Airport

© 2003, Cisco Systems, Inc. All rights reserved.

Company Confidential

21

## Access Codes können einfach eingerichtet werden

Cisco.com

- **All-in-one box prepaid solution**  
New 5.3 dynamic access code feature allows venues to offer prepaid access without the need for backend prepaid modules
- **Easy to use GUI interface**
- **Extensive calendaring system**
- **Bandwidth management offerings**
- **Pricing options**
- **Customizable customer classification system**

Hotspot Munich Airport

© 2003, Cisco Systems, Inc. All rights reserved.

Company Confidential

22

## BBSM liefert umfangreiche Reports

Cisco.com

- IP address
- MAC address
- Port / location
- Username
- Access code
- Time

Session ID	Username	Access Code	Port	Session ID	Session Type	Rate	Access Code	Session Status	End Time
1	ppppp	40	10.1.1.1	0	0	0	0	0	00:00:00
2	ppppp	40	10.1.1.1	0	0	1	0	0	00:00:00
3	ppppp	40	10.1.1.1	40	0	0	0	0	00:00:00
4	ppppp	40	10.1.1.1	40	0	2	0	0	00:00:00
5	ppppp	40	10.1.1.1	0	0	4	0	0	00:00:00
6	ppppp	40	10.1.1.1	0	0	1	0	0	00:00:00
7	ppppp	40	10.1.1.1	80	0	0	0	0	00:00:00
8	ppppp	40	10.1.1.1	80	0	2	0	0	00:00:00
9	ppppp	70	10.1.0.170	0	0	4	0	0	00:00:00
10	ppppp	70	10.1.0.170	0	0	1	0	0	00:00:00
11	ppppp	70	10.1.0.170	100	0	0	0	0	00:00:00
12	ppppp	70	10.1.0.170	100	0	2	0	0	00:00:00

Hotspot Munich Airport

© 2003, Cisco Systems, Inc. All rights reserved.

Company Confidential

23

## Technik



Hotspot Munich Airport

© 2003, Cisco Systems, Inc. All rights reserved.

Company Confidential

24

## Bandbreiten - Management

Cisco.com

- **BBSM offers 2 types of bandwidth management**

- Bandwidth throttling - on a per IP address basis (i.e. per user)**

- BBSM uses a driver on its internal NIC to perform this function

- Class of Service (CoS) - based upon a group of access codes.**

- BBSM sends commands via telnet to an external Cisco router, which in turn provides class based queuing.

- BBSM's bandwidth throttling parameters can be altered in 1 Kbps increments via the ASP code in the web page sets**

- The bandwidth reservation (CoS) can be altered in 1 Kbps increments via WEBconfig on BBSM**

Hotspot Munich Airport

© 2003, Cisco Systems, Inc. All rights reserved.

Company Confidential

25

## AtNat Functionality – Static Proxy and DNS

Cisco.com

- **Performs static proxy spoofing**
- **Performs static DNS spoofing**
- **Performs SMTP forwarding (email)**

*Diagram 2*

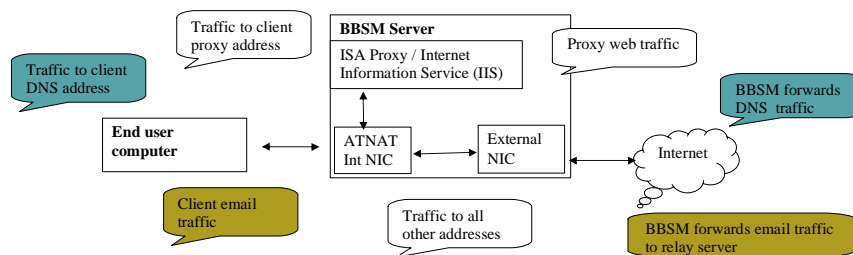

Hotspot Munich Airport

© 2003, Cisco Systems, Inc. All rights reserved.

Company Confidential

26

## Supported Cisco Access Layer Devices

Cisco.com



**Ethernet**



**Cable**



**Wireless**

<ul style="list-style-type: none"><li>• 1900</li><li>• 2900</li><li>• 2948</li><li>• 2950</li><li>• 2940</li><li>• 2970</li><li>• 2900 LRE</li><li>• 2950 LRE</li></ul>	<ul style="list-style-type: none"><li>• 3500</li><li>• 3550</li><li>• 3750</li><li>• 4000</li><li>• 4500</li><li>• 6509</li></ul>	<p><b>uBR 7200</b></p> <p><b>uBR 7100</b></p>	<p><b>AP 340</b></p> <p><b>AP 350</b></p> <p><b>AP 1100</b></p> <p><b>AP 1200</b></p>
-------------------------------------------------------------------------------------------------------------------------------------------------------------------------	-----------------------------------------------------------------------------------------------------------------------------------	-----------------------------------------------	---------------------------------------------------------------------------------------

Hotspot Munich Airport© 2003, Cisco Systems, Inc. All rights reserved.Company Confidential27

## Performance

Cisco.com

- **Cisco BBSM Performance ist abhängig von der Anzahl der gleichzeitigen Verbindungen**
  - 85 Mbps mit 250 gleichzeitigen Usern
  - 45 Mbps mit 1,000 gleichzeitigen Usern
- **Wenn der BBSMzentral installiert wird, dann nicht mehr als 25 Sites und/oder 50 Network Devices (i.e. Switches/APs) und/oder bis zu 1000 gleichzeitige User**

Hotspot Munich Airport© 2003, Cisco Systems, Inc. All rights reserved.Company Confidential28

## BBSM kann ein Besucher-WLAN managen

Cisco.com

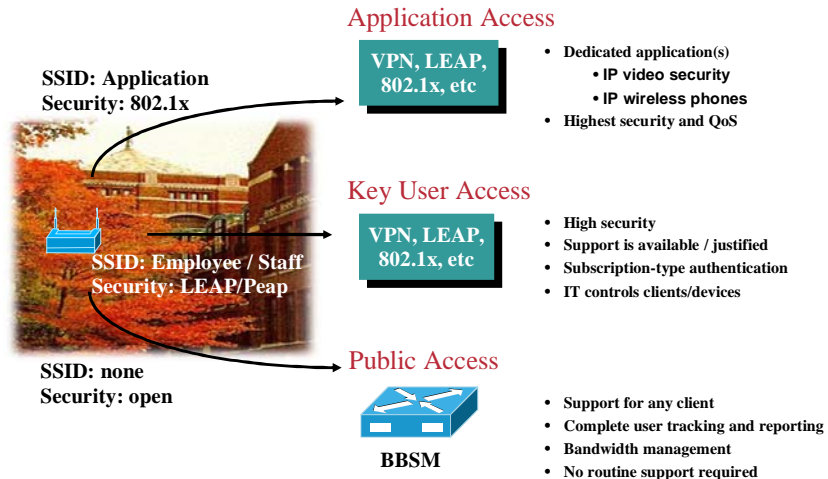

Hotspot Munich Airport

© 2003, Cisco Systems, Inc. All rights reserved.

Company Confidential

29

## Beispiel: Ein Gebäude

Cisco.com

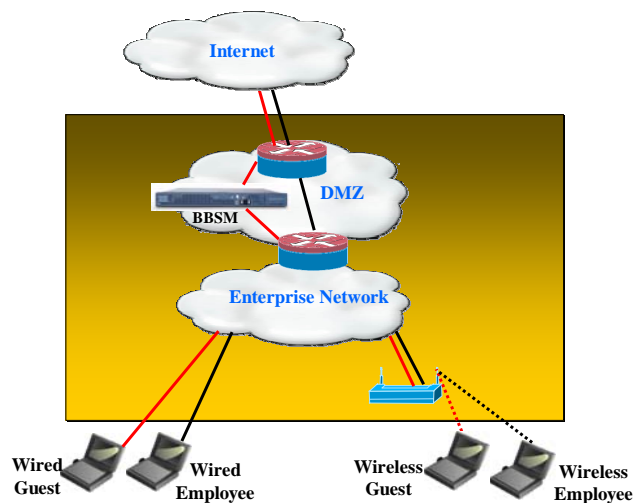

Hotspot Munich Airport

© 2003, Cisco Systems, Inc. All rights reserved.

Company Confidential

30

## Beispiel: mehrere Locations

Cisco.com

Venue with Central BBSM (leased line)

Venue with Local BBSM

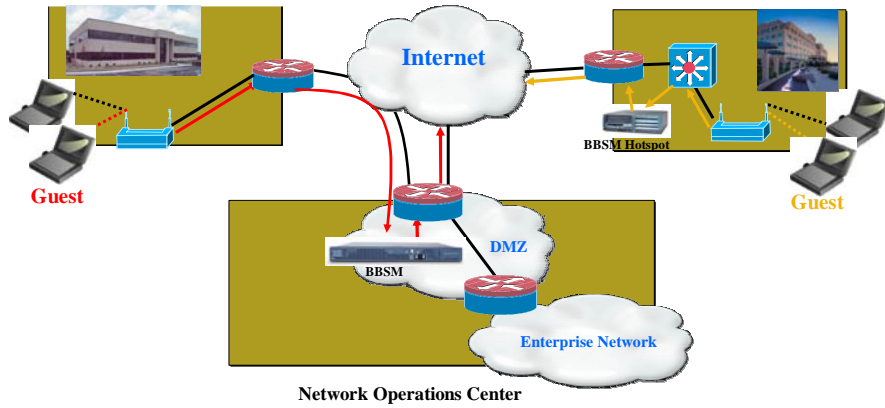

Hotspot Munich Airport

© 2003, Cisco Systems, Inc. All rights reserved.

Company Confidential

31

## BBSM arbeitet mit (fast) jeder Network Infrastruktur

Cisco.com

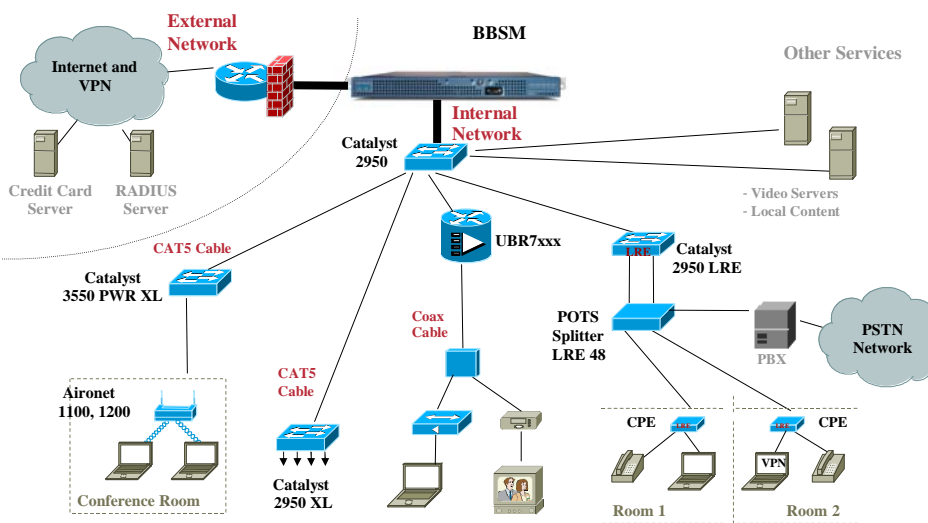

Hotspot Munich Airport

© 2003, Cisco Systems, Inc. All rights reserved.

Company Confidential

32



## Dual VLAN Support

Cisco.com

- Used to separate traffic on a network

For example, device traffic is queried on VLAN 1, while guest traffic is sent on VLAN 100

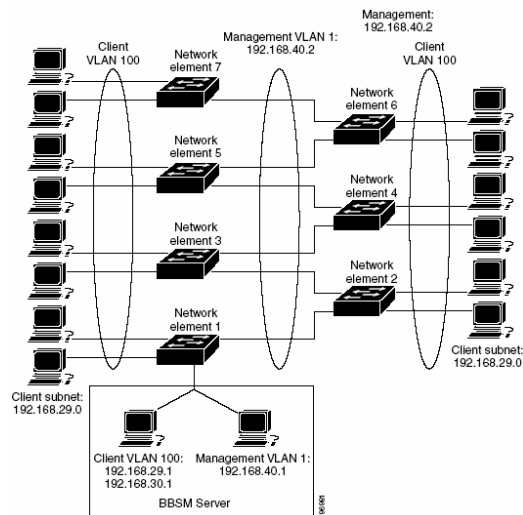

Hotspot Munich Airport

© 2003, Cisco Systems, Inc. All rights reserved.

Company Confidential

33

## SDK Support for BBSM 5.3 Hotspot

Cisco.com

- Due to the merging of the BBSM and BBSM Hotspot code bases, BBSM 5.3 Hotspot will now officially ship with SDK support
- The SDK will be released approximately 45 days after FCS

Hotspot Munich Airport

© 2003, Cisco Systems, Inc. All rights reserved.

Company Confidential

34

## Available Configurations

Cisco.com

- **BB-SM-SERVER5.3**  
High Performance 1RU pre-loaded Appliance with unlimited user license
- **BB-SM5.3-CDBUNDLE**  
Installable CD bundle including Windows 2000 Server, ISA Server, and BBSM software with unlimited user license
- **BB-SM-HOTSPTSVR5.3**  
High Performance Desktop appliance with 75 concurrent user license (hotel property management system license available separately)
  - BB-SM-HS150USRUPG**  
Hotspot License Upgrade to 150 concurrent users
  - BB-SM53HS-PMSOPTN**  
Hotspot PMS License upgrade
- **NOTE: All versions have identical code bases, but vary upon hardware and license offerings**

Hotspot Munich Airport

© 2003, Cisco Systems, Inc. All rights reserved.

Company Confidential

35

## Service Provider Solution SSG



Hotspot Munich Airport

© 2003, Cisco Systems, Inc. All rights reserved.

Company Confidential

36

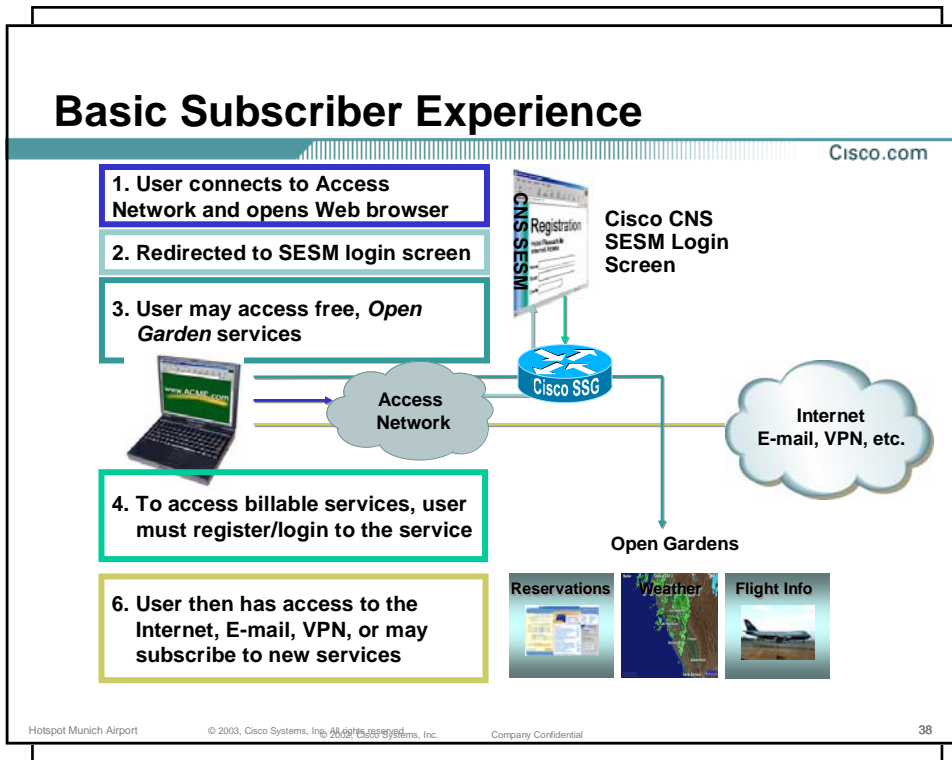
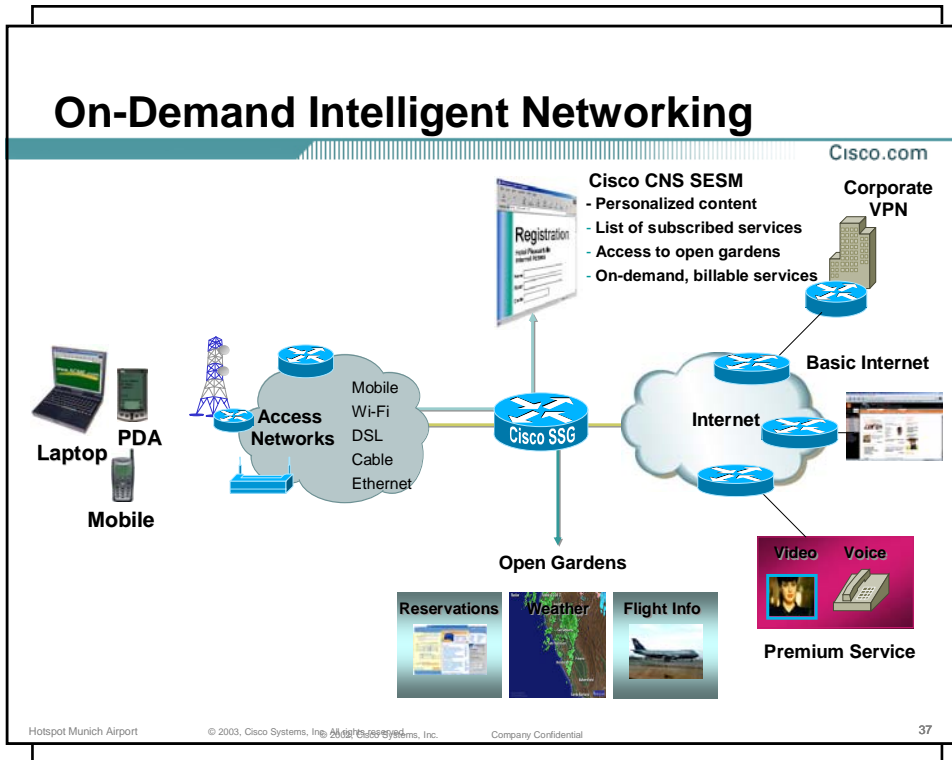

## Cisco Service Selection Gateway (SSG)

Cisco.com

- **Enables the delivery of on-demand, billable services**
- **Imposes sophisticated access control on a per-subscriber basis to network resources**
- **Allows subscribers to selectively access different services based on their L2 or L3 connectivity to the Service Providers**
- **Supports per user and per service QoS (SSG hierarchical policing)**
- **Offers prepaid or postpaid per service billing based on volume or time**

Hotspot Munich Airport

© 2003, Cisco Systems, Inc. All rights reserved.

Company Confidential

39

## Cisco CNS SESM

Cisco.com

- **Product portfolio for integrating on-demand service offerings into access networks**
- **Business Support System (BSS) integration point for Cisco SSG session and service control**
- **Software Development Kit (SDK) for extended subscriber portal development**
- **Standards-based, open architecture for deployment flexibility**

Hotspot Munich Airport

© 2003, Cisco Systems, Inc. All rights reserved.

Company Confidential

40

## Cisco CNS SESM Subscriber Portal

- Personalized content for device, browser, locale, and location
- Context-sensitive branding and advertising
- Subscription to on-demand services
- Seamless access to multiple services
- WAP support for PDA



Hotspot Munich Airport

© 2003, Cisco Systems, Inc. All rights reserved.

Company Confidential

41

## Service Deployment with Cisco CNS SESM

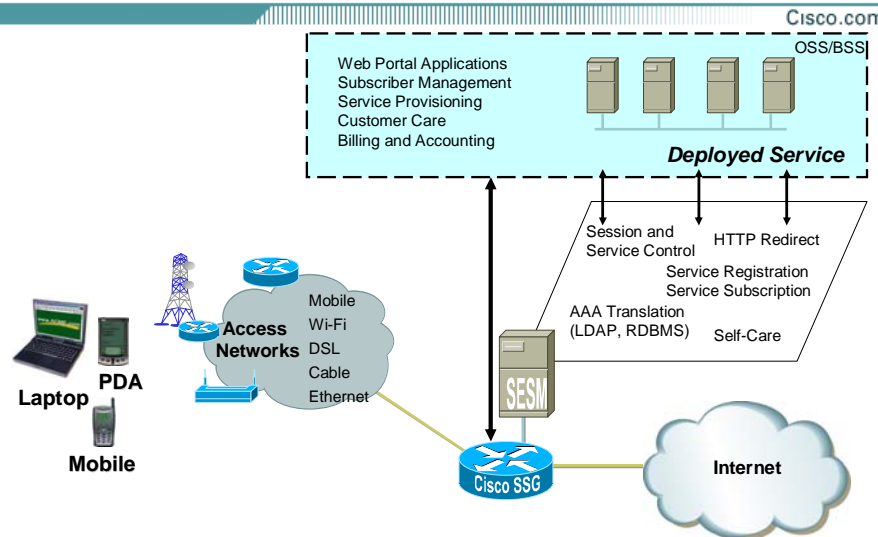

Hotspot Munich Airport

© 2003, Cisco Systems, Inc. All rights reserved.

Company Confidential

42

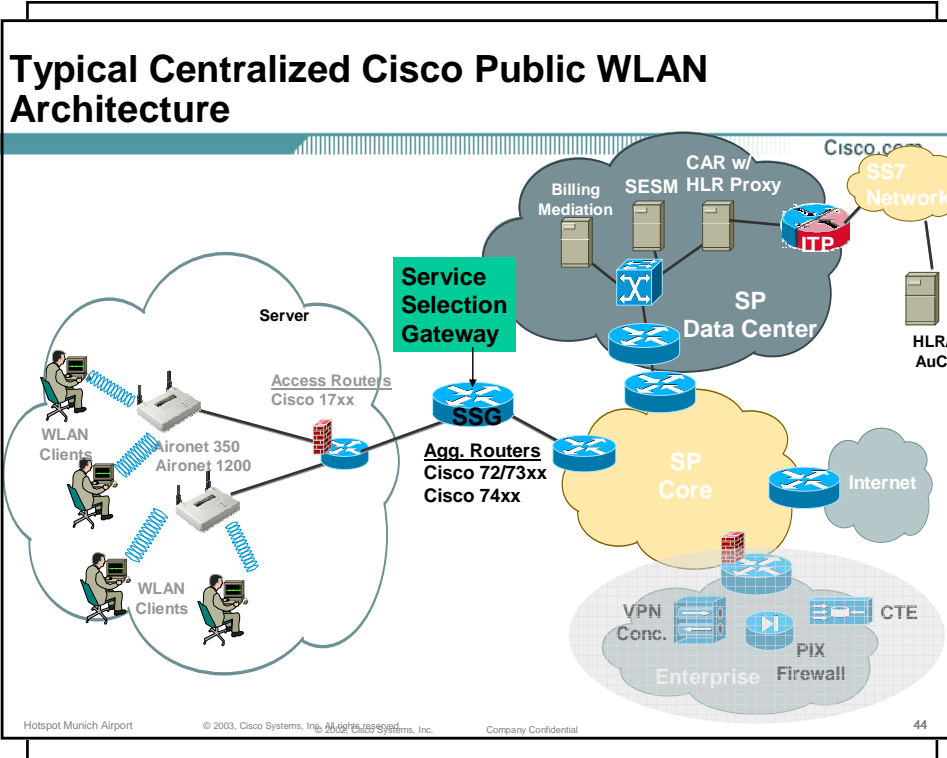
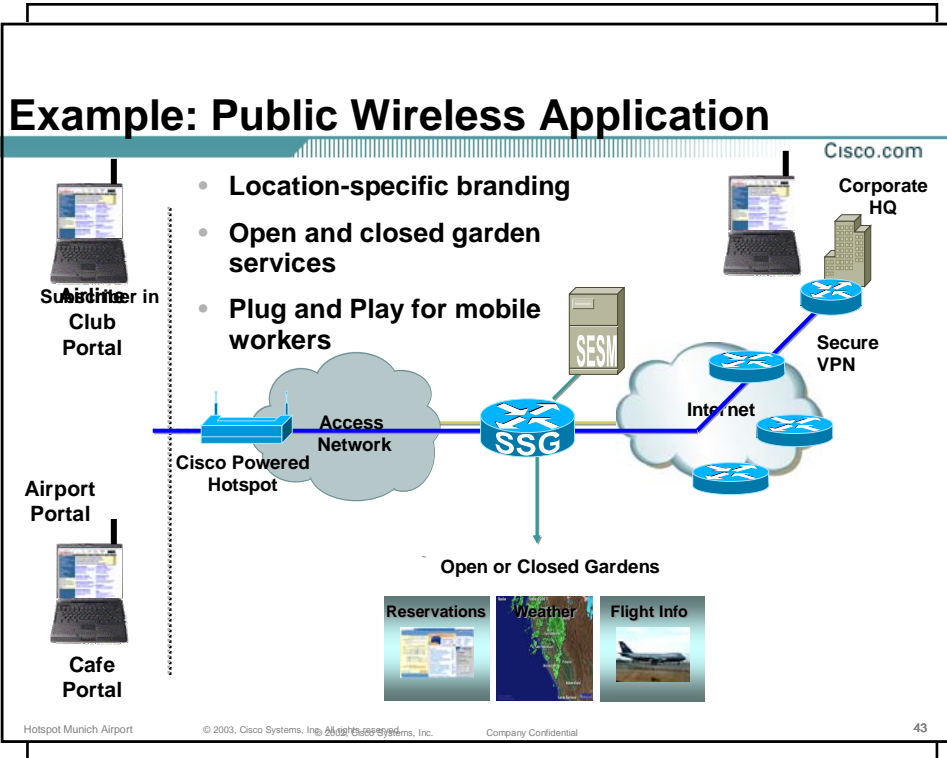

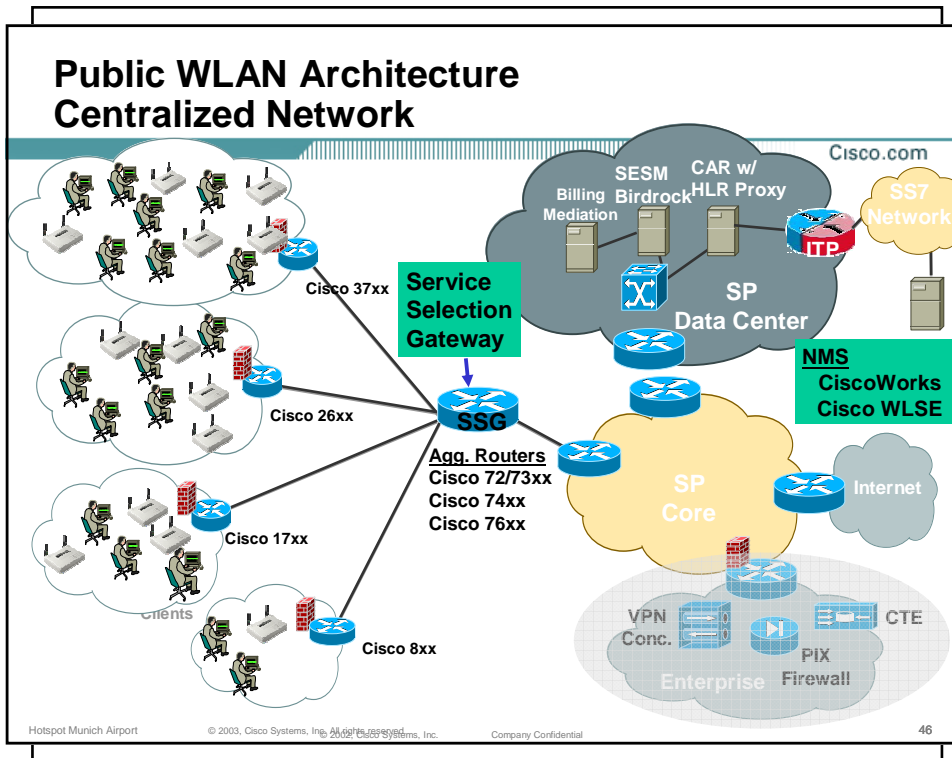
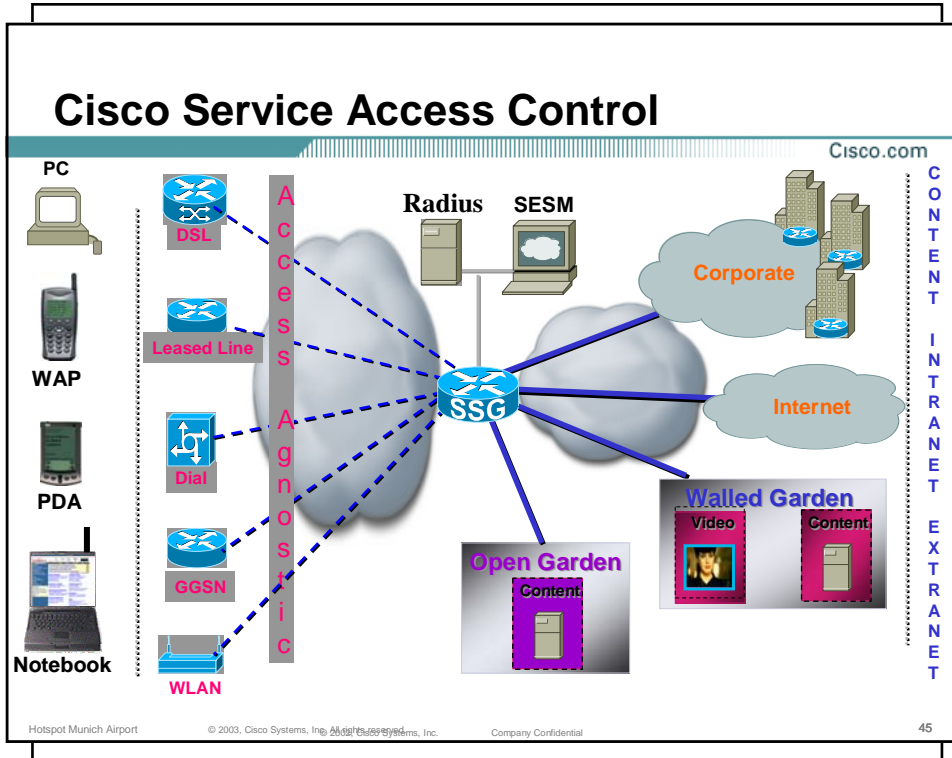

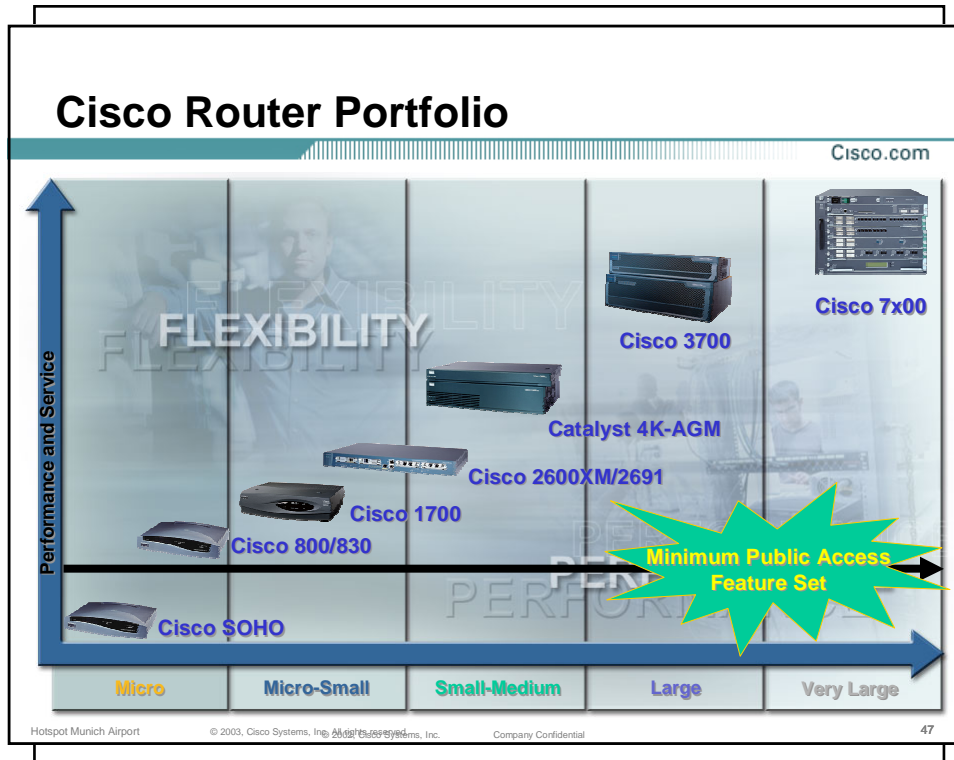

### Meet DORIS – Cisco’s lead in Service Selection

Cisco.com

- **DORIS** makes Cisco the best choice for BBA
  - D** – Density
  - O** – OPEX reduction
  - R** – Resiliency
  - I** – IP and IOS service
  - S** – System Scalability

Hotspot Munich Airport © 2003, Cisco Systems, Inc. All rights reserved. Company Confidential 48



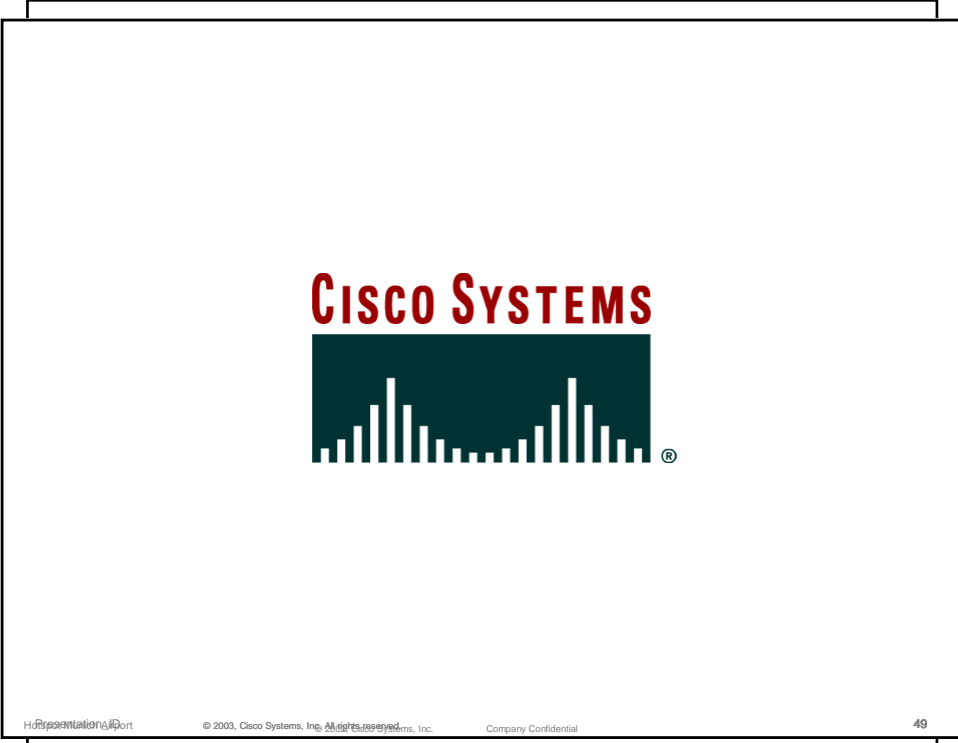

Presentation\_ID

© 2003, Cisco Systems, Inc. All rights reserved.

Company Confidential

49

